

FUJIIRYŌKI

Attached document

Controlled medical device

Machine Equipment 78 Electric therapy system for household

(JMDN Code: 70995000)

Low frequency/Electric potential combination household therapy system

FX - 14000

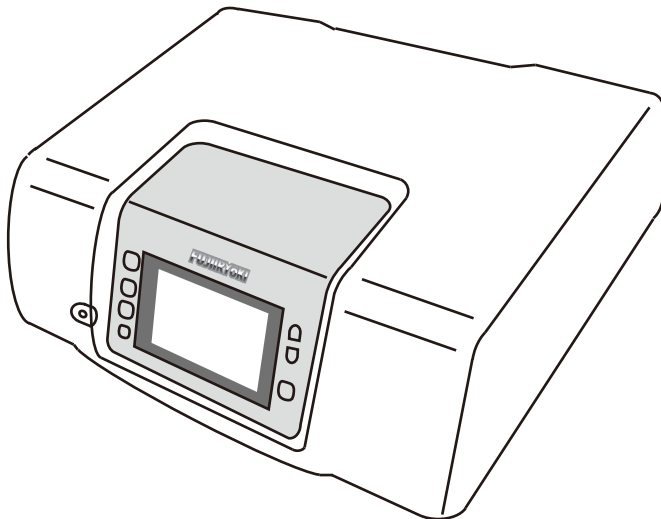

Model Number: FX-14000
Instruction Manual

Thank you very much for purchasing FX-14000.
This instruction manual contains important usage instructions.
Carefully read this user manual before use and use only as directed.
Please keep this manual in a safe place.



Contents

Please follow the safety instructions	2
Precautions for use	3~10
Name and function of each part	11~12
About potential treatment and low frequency treatment	13
How to use electric potential therapy equipment	14 ~19
How to use the detector	20
How to use low frequency treatment device	21~26
Is there a breakdown?	27~28
Main Specifications and Principles	29

Please follow the Safety instructions

Please read the attached document (Instruction manual) carefully before use. Incorrect use will cause an accident.

Pictorial display

In order to use the product safely and to prevent harm to you and other people and also to prevent damage to property, the usage instructions are displayed using images below. The display and their meanings are as mentioned below. Please understand the same before reading the document.



警告
(Warning)

This is displayed when there is a chance of death or serious injury to the user if the product is mishandled.



注意
(Caution)

This is displayed when there is a chance of minor injury or physical damage to the user if the product is mishandled.

Examples of pictorial display



Caution

Indicates warning or points of caution.

The actual "Warning" is shown within or next to the image.



General caution

Indicates general caution



Electric shock caution

Indicates caution for a risk of electric shock



Prohibition

Indicates prohibited actions.

The actual "Prohibition" is shown within or next to the image.



General Prohibition

Indicates general prohibited actions



Usage in bath or shower is prohibited

Indicates prohibition of use in a bath or shower



Disassembly Prohibited

Indicates prohibition of disassembly



Using with wet hands is prohibited

Indicates the prohibition of using with wet hands



Indication

Indicates actions that need to be followed.

The actual "Indication" is shown within or next to the image.



General Instruction

Indicates general instructions



Unplug the power plug from the outlet

Indicates that the power plug needs to be unplugged from the power outlet



Precautions for use

Please use after reading and understanding the Instruction manual.

Warning





 <p>Prohibition</p>	<p>Combination with other medical devices</p> <ul style="list-style-type: none"> Do not use it in combination with medical devices such as the following: <ul style="list-style-type: none"> Pacemaker, implantable type defibrillator and other implantable medical electrical devices which are susceptible to electromagnetic interference Mountable medical electrical devices such as electrocardiograph. <p>Applicable subject (patient)</p> <ul style="list-style-type: none"> Do not use it if you are diagnosed with heart disease and are restricted from daily extreme exercise.
--	--

Warning

 <p>Prohibition</p>	<ul style="list-style-type: none"> This therapy device cannot treat several people at the same time. Do not connect anything other than the designated electrode to this therapy device. Do not connect the electrode that is not be used to the equipment. Also do not put in the slot. Do not put the electrode on to the head area or any skin area affected by disease. Do not use other than with AC 220 V power supply. Do not drop the main unit or subject to electrical shock. If dropped by mistake, please inspect for any abnormality. Do not use for purposes other than treatment as described in the instruction manual.
 <p>Caution</p>	<ul style="list-style-type: none"> The following persons must consult a healthcare professional before using this product. <ol style="list-style-type: none"> If you have malignant tumors If you have heart diseases If you are pregnant or have recently given birth If you have a body temperature above 38 °C (with a fever) <ul style="list-style-type: none"> Example 1: Strong period of acute inflammatory symptoms (e.g. fatigue, chills, blood pressure fluctuations, etc.) Example 2: In case of weakness If you are prescribed rest If you are suffering from spinal fractures, sprains, muscle tears, etc. If you have perceptual disorder caused by advanced endovascular disorder due to diabetes etc. If you have any abnormalities (infections, wounds, etc.) in the skin at the application site when performing low frequency treatment When using comfortable setting of therapy (treatment time more than 1 hour), if you are suffering from <ul style="list-style-type: none"> high blood pressure arrhythmia sleep apnea asthma If you are receiving medical treatment by physicians, especially due to abnormalities in the body Those mentioned below should always be accompanied by a helper <ol style="list-style-type: none"> Elderly people, children, people with sensory disorders Those who can not understand the contents of the instruction manual <ul style="list-style-type: none"> There is a risk of accident and getting physically hurt. <p>When any other person uses (friend etc.) accompany them or let them use only after explaining. Please explain to them that they can use it after reading the instruction manual.</p> Do not use for infants and people with physical disabilities. <ul style="list-style-type: none"> There is a risk of accident and getting physically hurt.
 <p>Disassembly prohibited</p>	<ul style="list-style-type: none"> Never modify, disassemble, or repair this instrument. <ul style="list-style-type: none"> There is a risk of accident and getting physically hurt.

Terms of use and environmental precautions



Warning



 Prohibited	<ul style="list-style-type: none"> Do not use it simultaneously with other treatment equipment. ◆ May cause electric shock or malfunction
	<ul style="list-style-type: none"> Do not use for purposes other than treatment. ◆ May cause electric shock or injury.
	<ul style="list-style-type: none"> Do not let the treatment electrode touch the metal. ◆ May cause electric shock or malfunction
	<ul style="list-style-type: none"> Do not use with quilts containing conductive material such as metal fiber. ◆ May cause electric shock, injury, or malfunction.
	<ul style="list-style-type: none"> Do not let children use it. (Except when used under the supervision of a guardian, doctor or expert) Also do not let them play with the equipment body or electrodes and do not let them ride on it.
	<ul style="list-style-type: none"> Do not pierce the electrode with a pin or damage it with a knife. ◆ May cause electric shock, injury or malfunction.
	<ul style="list-style-type: none"> Do not use the low frequency pad when its surface is missing or broken. ◆ May cause electric shock or injury.
	<ul style="list-style-type: none"> Do not use when drunk or when you have taken sleeping pills.
	<ul style="list-style-type: none"> Do not bend the conduction sheet strongly, twist the conduction sheet cord, the power cord, the low-frequency cord, or place heavy objects on it. Also, do not wash the conduction sheet and the low-frequency pad. ◆ The cord may get damaged and may cause electric shock or injury.
	<ul style="list-style-type: none"> Do not use low frequency pads near the heart, head, face, mouth, pubic area, on infected skin, etc. ◆ May cause accidents and physical injury.
 Usage in bath prohibited	<ul style="list-style-type: none"> Do not use in high humidity areas such as bathrooms. ◆ Short-circuit or overheating may result in fire or electric shock. Do not wash the instrument or apply water. Also do not use in places with high moisture or humidity such as bathroom or kitchen. ◆ Short-circuit or overheating may result in fire or electric sh
 No wet hands	<ul style="list-style-type: none"> Do not connect or disconnect the power plug or appliance side plug with wet hands.
 Unplug the plug	<ul style="list-style-type: none"> Always unplug the power cord when unit is not in use. ◆ May cause accidents such as short-circuit, electric shock, fire, etc. when the power is turned on again. When unplugging the power plug, always hold the tip of the plug and do not hold the cord to pull it out. ◆ Pulling on the cord can scratch the cord and lead to fire or electric shock.

Caution



 Caution	<ul style="list-style-type: none"> If results are not evident even after using for a while, consult a doctor or an expert. If symptoms such as fever, redness, itching etc. appear by using this product, stop using and consult a doctor.
--	--

Precautions before use

 Warning	
 Prohibition	<ul style="list-style-type: none"> • Please install the electrode correctly. Do not use a bent or rolled electrode. • Do not use the electrode and cord if torn or damaged. <ul style="list-style-type: none"> ◆ May cause electric shock or injury.
 Instruction	<ul style="list-style-type: none"> • Ensure that all cords are properly and securely connected so as not to easily detach. • Use it after confirming that the operation switch etc. operates normally. • If the equipment is not used for a while, ensure that the equipment operates normally and safely before using it. <ul style="list-style-type: none"> ◆ Ensure that the buttons, display panel, etc. operate properly before use. ◆ Wipe of the dust and dirt from the cord and power plug and use it after cleaning. ◆ If the conduction sheet and insulating mat are moist, dry them before using.



 Caution	
 Prohibition	<ul style="list-style-type: none"> • Do not use electric kotatsu, electric heating blankets and other thermal equipment, nursing care equipment that use power outlets, etc. inside the insulation mat even if the power is not turned on. <ul style="list-style-type: none"> ◆ May cause malfunction of the device.
	<ul style="list-style-type: none"> • Do not insert foreign objects such as inflammable objects, pins, wires, metal, etc. inside the main body from the power cord insertion port, conduction sheet plug insertion port etc. <ul style="list-style-type: none"> ◆ May cause electric shock, fire, equipment failure.
	<ul style="list-style-type: none"> • Do not twist or place heavy objects on the cord of accessories etc. <ul style="list-style-type: none"> ◆ Damage or deterioration of the cord can cause electric shock or fire.
	<ul style="list-style-type: none"> • Do not use items other than the items written on the bag of the low frequency pad. <ul style="list-style-type: none"> ◆ Risk of electric shock and accident.
	<ul style="list-style-type: none"> • Do not use it for a long time (more than 30 minutes) if you are using it for the first time. <ul style="list-style-type: none"> ◆ Unreasonable usage may cause physical injury.
	<ul style="list-style-type: none"> • Do not use with insufficient connections to power plug and when there is inconvenient wiring. <ul style="list-style-type: none"> ◆ Short-circuit or overheating may result in fire or electric shock. ◆ Please connect properly and firmly until the end.
	<ul style="list-style-type: none"> • Do not install or use in the following places. <ol style="list-style-type: none"> 1. Places such as bathrooms which have high temperature and humidity 2. Places with high humidity and dust 3. Places which have oil smoke or steam 4. Near heat equipment and places exposed to direct sunlight <ul style="list-style-type: none"> ◆ Danger of fire, electric shock, or equipment failure. 5. Place close to a TV/audio equipment or the same outlet <ul style="list-style-type: none"> ◆ May adversely affect the sound of the television and the magnetic disk. 6. Unstable place <ul style="list-style-type: none"> ◆ If placed on a wobbling table, a slanted surface, a step or a high place, it may fall and cause injury. 7. Place where people are passing by <ul style="list-style-type: none"> ◆ Failure to do so may cause injuries to the cord of the conduction sheet or contact failure.
	<ul style="list-style-type: none"> • Do not place containers containing water (vases, water, cups containing drinks, etc.) on top of this device. <ul style="list-style-type: none"> ◆ Failure to do so may result in fire, electric shock, or equipment malfunction.
	<ul style="list-style-type: none"> • Do not ride on the body or place heavy objects on it. Also do not knock it down. <ul style="list-style-type: none"> ◆ May cause injury or malfunction.
	<ul style="list-style-type: none"> • Do not use for pets. <ul style="list-style-type: none"> ◆ There are some animals that have weak tolerance for electricity, and it may result in death or physical injury.

Caution

 Prohibition	<ul style="list-style-type: none"> • Do not use the conduction sheet and insulation mat when wet or moist. <ul style="list-style-type: none"> ◆Moisture not only reduces the insulation effect but is also a risk of electric shock and fire. Please dry it thoroughly before use. ◆Do not expose to direct sunlight, dry it in the shade. ◆At the same time use blankets, sheets etc. that are dry. • Two people should not use the conduction sheet at the same time. <ul style="list-style-type: none"> ◆It may cause painful stimulation or cause unexpected accidents.
 Instruction	<ul style="list-style-type: none"> • Before usage or after a long period of usage inactivity, confirm that the operation of the equipment/accessories is normal and safe. <ul style="list-style-type: none"> ◆Use it after confirming that the button and the display work properly. ◆Use it after cleaning and wiping out the dirt and dust from the power plug ◆If the conduction sheet, insulation mat, etc. are moist, dry before using. • If you are using for the first time, read the instruction manual before using. • Ensure that only the power supply sheet and power cord of this device are used. <ul style="list-style-type: none"> ◆Use of conduction sheets, power cords, etc. of other equipment may cause malfunction or electric shock. • Insert the power plug and the outlet securely till the base. Also, do not use the unit when the plug is damaged or it is loosely plugged in. <ul style="list-style-type: none"> ◆It may cause a short circuit, fire, or ignition. • Use treatment time and output voltage suitable for your physical condition. • Do not connect unusable conduction sheet or low frequency cords to the equipment and do not let them touch the body. <ul style="list-style-type: none"> ◆Risk of an unexpected accident such as an electric shock. • A low-frequency pad for exclusive use is always attached to the electrode of the low frequency cord. <ul style="list-style-type: none"> ◆Using non-dedicated pads can cause injury or malfunction. • When accessories (conduction sheet, low-frequency cord, low-frequency pad, power cord, insulation mat) are torn or damaged, replace them with new ones without using them. <ul style="list-style-type: none"> ◆May cause injury or electric shock by tearing or bruising. • When sitting on a chair for treatment, first ride on the insulating mat and then sit on the conduction sheet. (Keep the chair more than 5 cm from the wall.) <ul style="list-style-type: none"> ◆Risk of a sudden electric shock. • Ensure that the conduction sheet and the low frequency pad plug are completely connected and install them correctly. <ul style="list-style-type: none"> ◆May cause breakdown and accident. • Remove accessories such as precious metals (necklaces and earrings) and watches before use. Also, do not let metal sheets touch the conduction sheet etc. <ul style="list-style-type: none"> ◆Risk of an electric shock or malfunction.
 Caution	<ul style="list-style-type: none"> • Do not handle this product while wearing electronic equipment, magnetic/IC cards etc. <ul style="list-style-type: none"> ◆May cause damage to equipment or damage to the card.

Precautions during use

Warning

 Prohibition	<ul style="list-style-type: none"> • Do not sleep when using the product. <ul style="list-style-type: none"> ◆ Low frequency pads stick to unexpected places, and there is a risk of ill health or injury.
 Instruction	<ul style="list-style-type: none"> • If a failure is found in the equipment, immediately stop using it and turn off the power. • If you have any abnormal feelings in the body stop using immediately. • While using do not touch surrounding people or objects. <ul style="list-style-type: none"> ◆ This may cause electric shock. • People around you should not touch you during the treatment. <ul style="list-style-type: none"> ◆ This may cause electric shock. • In case of power failure, immediately turn off the power and unplug the power plug. <ul style="list-style-type: none"> ◆ It is dangerous when the power comes back. • Turn off the power supply when correcting the connection failure of the conduction sheet, the low-frequency cord, and the low-frequency pad. <ul style="list-style-type: none"> ◆ It may cause electric shock or injury. • Potential therapy must always be performed in an insulation mat. <ul style="list-style-type: none"> ◆ Not only does it cause insufficient results, it may also cause electric shock. • Low frequency treatment to one body part should not be done for more than 30 minutes. In addition, treatment to the same site should be completed within 5 minutes. <ul style="list-style-type: none"> ◆ Muscles may fatigue causing bad health and injuries. • For the Easy Setting, Fast Setting and Manual Setting of the Electric potential therapy, use within 60 minutes and not continuously. <ul style="list-style-type: none"> ◆ It may cause poor physical condition. • Discontinue use as soon as you feel sick or uneasy and follow the instructions of your doctor. <ul style="list-style-type: none"> ◆ It may cause poor physical condition.

Caution

 Prohibition	<ul style="list-style-type: none"> • When using the product, do not insert a metal rod or the like into the plug insertion port, do not plug or unplug the plug. <ul style="list-style-type: none"> ◆ There is a danger of electric shock. • Do not place the main unit on the conduction sheet with the power turned on. <ul style="list-style-type: none"> ◆ It leads to malfunction of the main unit. • Do not use while covered with blankets or bedding. <ul style="list-style-type: none"> ◆ It leads to fire and damage to the main unit. • The strength of the low frequency treatment device is not excessively strengthened. <ul style="list-style-type: none"> ◆ The skin may be excessively irritated and may have tingling or turn red. • Do not use earphones or headphones of TV or radio etc. when using the product. Also, do not use electronic devices such as mobile phones and personal computers. <ul style="list-style-type: none"> ◆ It may cause equipment breakdown and malfunction. • Do not handle cell phones near this instrument. <ul style="list-style-type: none"> ◆ It may cause malfunction.
--	---





Caution





Instruction

- In the following cases immediately stop treatment, turn off the power, and unplug the power plug.
 - (1) When an abnormality such as an earthquake occurs.
 - (2) When there is a thunder storm.
 - (3) When power failure occurs.
 - ◆ May cause unexpected breakdowns and accidents.
- When discontinuing use, be sure to turn off the power.
- When re-placing low frequency pads on other parts of the body during low frequency treatment, always lower the output level to "0" before re-placing.
 - ◆ Risk of sudden electric shock
- During low frequency treatment, do not paste it on another person.
 - ◆ Risk of sudden electric shock
- If an error occurs during use, immediately stop using it, turn off the power, and disconnect the power plug from the outlet.
If any of the following symptoms appear, please consult your nearest Fuji Medical Devices Customer Support Center.
 - (1) There is smoke and/or a strange smell.
 - ◆ Confirm that smoke ceases to exist and request repair at your place of purchase or take it to Fuji Medical Devices Customer Consultation Center.
 - (2) Foreign matter or water entered inside and caused damage.
 - (3) The main unit, plug and cord become abnormally hot.
 - (4) A strange sound is heard, the display etc. disappears
 - ◆ Repair by customer is dangerous so never do it on your own. Request repair at your place of purchase or take it to Fuji Medical Device Customer Consultation Center.

Usage and storage caution

 Caution	
 Prohibition	<ul style="list-style-type: none"> To remove the cords, do not exert excessive force such as pulling out the cord. Also, do not fold. <ul style="list-style-type: none"> ◆It may cause cord damage, electric shock, fire, or injury.
	<ul style="list-style-type: none"> When moving the main unit, do not leave it in places where the temperature can get abnormally high or humid. <ul style="list-style-type: none"> ◆It may cause malfunction or accident.
	<ul style="list-style-type: none"> Do not give any external shock to the unit. <ul style="list-style-type: none"> ◆It may cause malfunction or accident.
	<ul style="list-style-type: none"> After use, do not forcibly bend or roll up the conduction sheet/insulation mat. <ul style="list-style-type: none"> ◆It may cause malfunction or accident.
	<ul style="list-style-type: none"> Do not leave the low frequency pad attached to the affected part on the body. <ul style="list-style-type: none"> ◆It may cause skin irritation and inflammation.
	<ul style="list-style-type: none"> If it is time to replace the low frequency pad do not use it. Instead, replace it with a new one. <ul style="list-style-type: none"> ◆It may cause skin irritation, inflammation and poor physical condition.
 Instruction	<ul style="list-style-type: none"> Keep it clean so as not to hinder the next use, keep it in a place with little humidity.
	<ul style="list-style-type: none"> When cleaning or not using, always unplug the power cord from the power outlet.
	<ul style="list-style-type: none"> Always turn off the power button and remove the conduction sheet plug from the conduction sheet plug inlet after use.
	<ul style="list-style-type: none"> Remove the cords when moving the main body. <ul style="list-style-type: none"> ◆It may cause damage to the cord, electric shock, or injury.
	<ul style="list-style-type: none"> Remove the battery used for the voltage detector if it is not to be used for a long period. <ul style="list-style-type: none"> ◆Failure to do so may result in breakdown of the voltage detector.

Handling precautions



 Caution	
 Prohibition	<ul style="list-style-type: none"> Do not wipe with benzine, thinner, alcohol etc. <ul style="list-style-type: none"> ◆It may cause cracks, degenerations and the paint may peel off.
	<ul style="list-style-type: none"> Do not apply volatile substances such as insecticides. <ul style="list-style-type: none"> ◆There is a danger of electric shock or fire.
	<ul style="list-style-type: none"> Do not bring in contact with rubber and vinyl products, newspapers, etc.
	<ul style="list-style-type: none"> Do not use if the electrode is wet. <ul style="list-style-type: none"> ◆It may cause electric shock or malfunction.

Caution

 Instruction	<ul style="list-style-type: none"> • Mishandling may cause problems, so strict observance of usage methods and usage precautions is required.
	<ul style="list-style-type: none"> • Clean the product according to the precautions.
	<ul style="list-style-type: none"> • When cleaning, unplug the power plug from the outlet.
	<ul style="list-style-type: none"> • Wipe off dirt gently with a soft cloth. When it gets very dirty, soak the cloth in a solution diluted with water and a neutral detergent, squeeze it hard, wipe it off with a dry cloth.
	<ul style="list-style-type: none"> • When using chemical cloth, follow the instructions.
	<ul style="list-style-type: none"> • Drying of conduction sheet and insulation mat should be done in the shade.
	<ul style="list-style-type: none"> • Dispose of consumables, residues, etc., and disposal of equipment and accessories after the end of their lives should be done according to local ordinances.

Storage precautions

Caution

 Instruction	<ul style="list-style-type: none"> • When storing, unplug the power plug from the outlet and disconnect the power cord from the main unit. When unplugging the power plug, hold the cord and do not forget to hold the plug at the tip.
	<ul style="list-style-type: none"> • Ensure that pets such as dogs and cats do not hurt the cord, main body, conduction sheet, insulation mat etc. <ul style="list-style-type: none"> ◆ There is a possibility of malfunction or electric shock.
 Prohibition	<ul style="list-style-type: none"> • Do not store in places where it may get wet . <ul style="list-style-type: none"> ◆ It may cause a malfunction.
	<ul style="list-style-type: none"> • Do not store in a place exposed to oil smoke or steam. <ul style="list-style-type: none"> ◆ It may cause failure or malfunction.

Names and functions of each part
(Shape, structure and principle)

<Body>

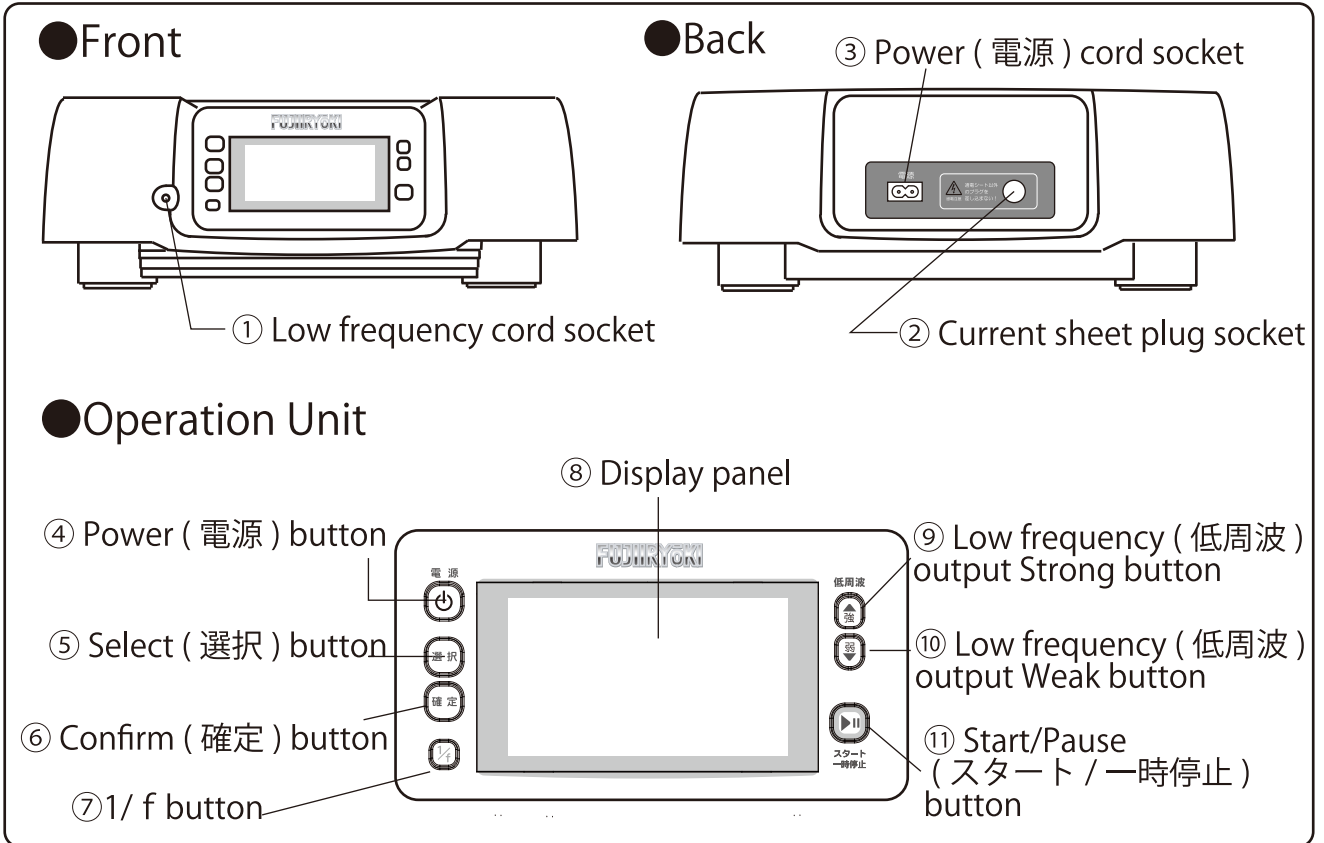

<Accessories>

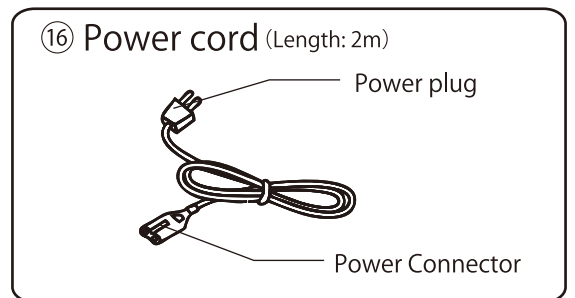
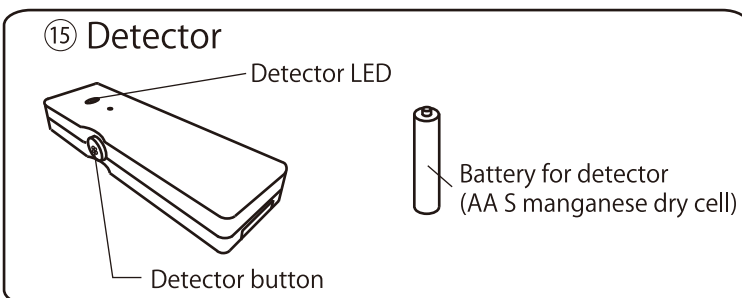
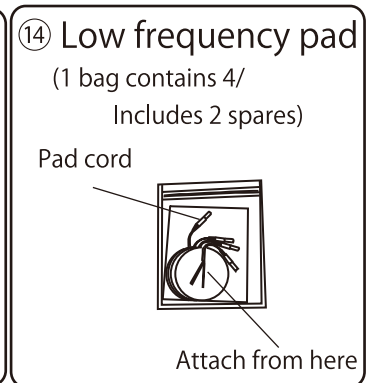
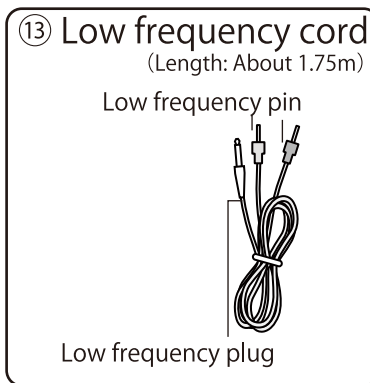
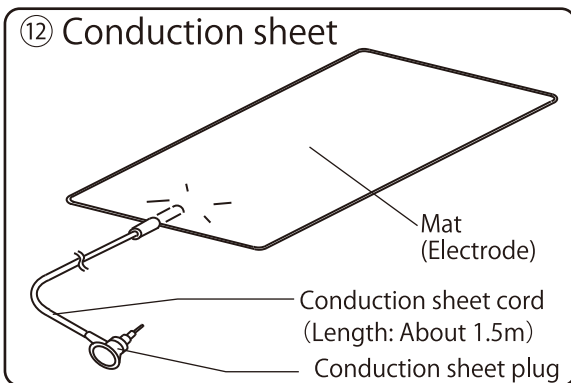

⑰ Insulation mat

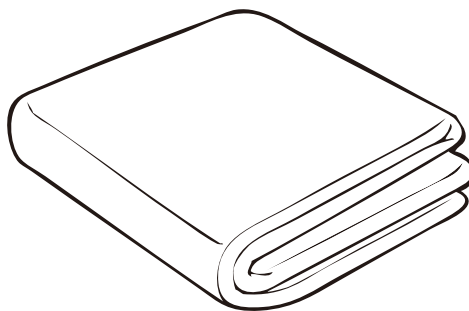

Size: 1200 × 2000 mm

Operating principle

This product incorporates a low frequency treatment part that treats the affected part by flowing a weak low frequency current from the surface of the skin and a potential treatment part that treats the human body by placing it in an alternating electric field, an electric therapy apparatus for household use with a power supply use of AC220V 50/60Hz. As an electric potential therapy device, it has a program function that automatically changes the output pattern of the output voltage. As a low frequency therapy device, the output of the set frequency, waveform, etc. has a program function to switch into various combinations of patterns. Potential treatment and low frequency treatment can not be used at the same time, and the setting and operation state of the instrument are displayed on the display panel in the center of the main unit.

Name	Function
①Low frequency code socket	It is a socket to insert low frequency cord.
②Conduction sheet plug socket	It is a socket to insert the conduction sheet plug of the conduction sheet.
③Power (電源) cord socket	It is a socket to insert the power connector of the power cord.
④Power (電源) button	It is a button to turn the power supply on/off.
⑤Select (選択) button	It is a button to select treatment mode and setting.
⑥Confirm (確定) button	It is a button to confirm the treatment mode and setting.
⑦1/f button	It is a button to set the 1/f vibration.
⑧Display panel	It is a panel showing the status of settings and the state of treatment.
⑨Low frequency (低周波) output Strong button	It is a button to increase frequency output during low frequency treatment.
⑩Low frequency (低周波) output Weak button	It is a button to decrease frequency output during low frequency treatment.
⑪Start/Pause (スタート / 一時停止) button	It is a button to start treatment or pause during treatment.
⑫Conduction sheet	It is a treatment electrode used for electric potential treatment.
⑬Low frequency cord	It is a cord used at low frequency treatment. Use the low frequency pad after connecting it to the low frequency pin.
⑭Low frequency pad	It is a treatment guide to be used by being attached to the body during low frequency treatment. Use it after connecting to a low frequency cord.
⑮Detector	It is a device for checking electric potential at the time of treatment.
⑯Power cord	It is a cord for supplying power to the main unit.
⑰Insulation mat	It is a mat laid under the chair etc. during electric potential treatment.

※Treatment electrode generically includes conduction sheet, low frequency pad, low frequency cord.



Do not use anything other than accessories supplied with this product for this instrument.

◆It can lead to electric shock and breakdown of the main unit.

About potential treatment and low frequency treatment (Purpose of use and effect)

Potential therapy

In potential therapy a certain amount of potential is given to the body to relieve headache, stiff neck insomnia and chronic constipation.

■ Operating principle

When an effective electric energy is given to the body, an electric field is generated from the high electric potential. The electric potential therapy uses this principle.

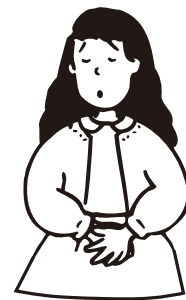

Headache remission Stiff shoulder remission Insomnia remission Chronic constipation remission

- For use at home

Low frequency treatment

Low frequency treatment is to provide a weak current from the outside of the skin, loosen the hardened muscles, improve blood circulation and relieve pain and stiffness.

■ Operating principle

When pulsed current of a relatively low frequency is applied from the skin surface of the body at a certain level, nerves and muscles are stimulated and the muscles contract. Depending on the conducting energy condition, the reaction of the muscles changes, and it can give stimulus of various senses



Stiff shoulder remission

- For use at home



Prevention of atrophy of paralyzed muscle
and massage effect

How to use electric potential therapy equipment (Usage method etc.)

Preparation before use

1 Place the unit on a level surface so that it does not collapse.

2 Connect the conduction sheet.

Insert the conduction sheet plug into the conduction sheet plug socket.



Please insert the conduction sheet plug securely to the base of the conduction sheet plug socket.

Caution

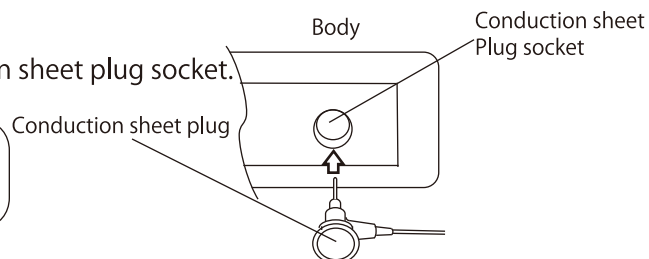

3 Prepare the insulation mat.

Spread out the insulation mat without folding it to cover the whole area.

4 Prepare the conduction sheet.

Place the wooden chair or futon on the insulating mat according to the treatment posture and setup the conduction sheet.

① When sitting on a chair for treatment, place a wooden chair on the insulation mat and spread the conduction sheet on it.
(※ Ensure that the chair is 5 cm away from the wall.)

② If you are lying down for the treatment, lay your cushion on an insulating mat, spread the conduction sheet around the waist and spread it on your hands.

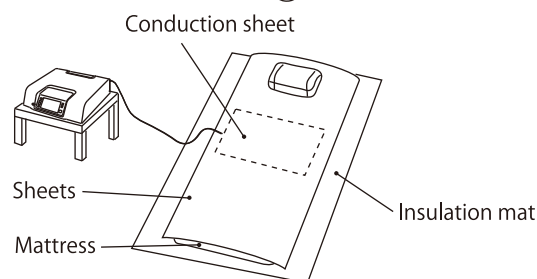
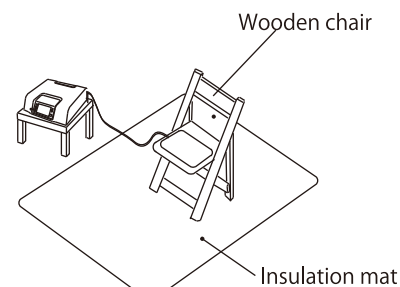

5 Connect the power cord.

Insert the power connector into the power cord on the main unit.

Plug the power plug into a household outlet.



Please confirm that it is securely inserted to the base.

Caution

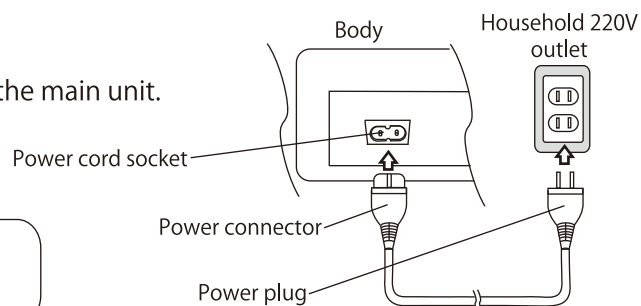

6 Prepare for use.

① When sitting on a chair to do treatment, sit directly on the prepared conduction seat.

② When lying down, put your body on the prepared sheets etc.

Method of operation

1 Turn on the power.

Press the Power (電源) button on the main unit and turn on the power. When you press the Power (電源) button, the display as shown below appears on the display panel, and after 2 seconds it switches to 2 Treatment selection screen.

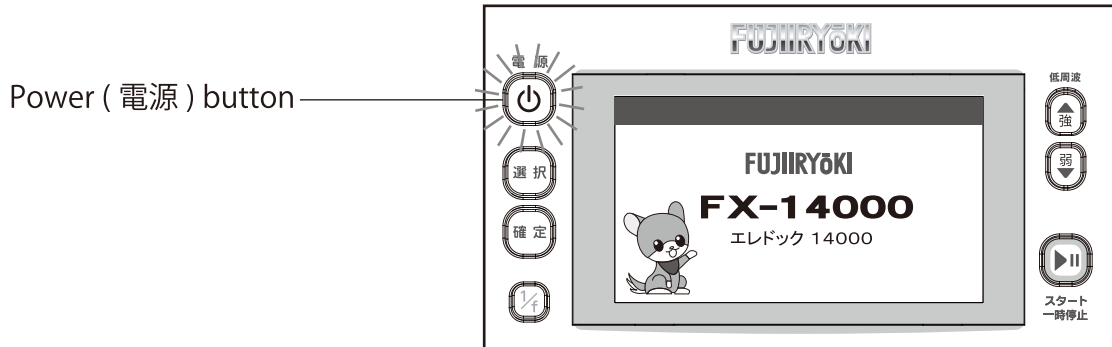

2 Select the potential.

Select the Potential (電位) with the Select button and press the Confirm button. If you press the Select (選択) button the treatment icon selection changes from "Potential" (電位) ⇒ "Low frequency" (低周波) ⇒ "Potential" (電位). Press the Confirm (確定) button to move to point 3 Potential setting selection screen.

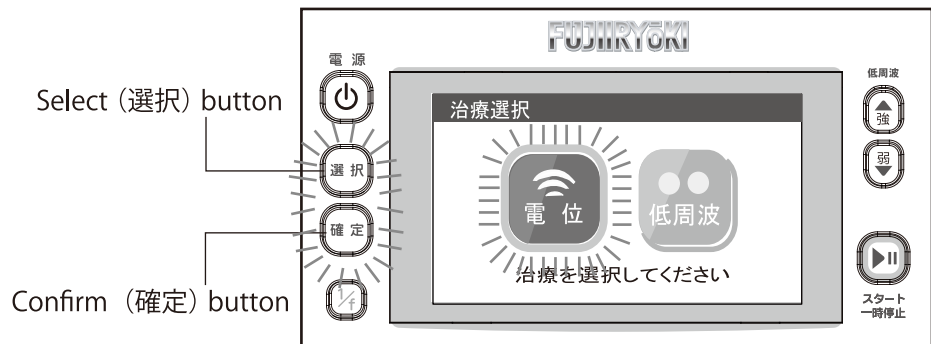

3 Select your favorite setting.

Select the setting with the select (選択) button. If you press the Select (選択) button the potential course icon selection changes from Easy (やさしい) ⇒ Fast (しっかり) ⇒ Comfortable (ゆったり) ⇒ Manual (マニュアル) ⇒ Easy (やさしい) ⇒ ... Select the setting you want and decide with the confirm button.

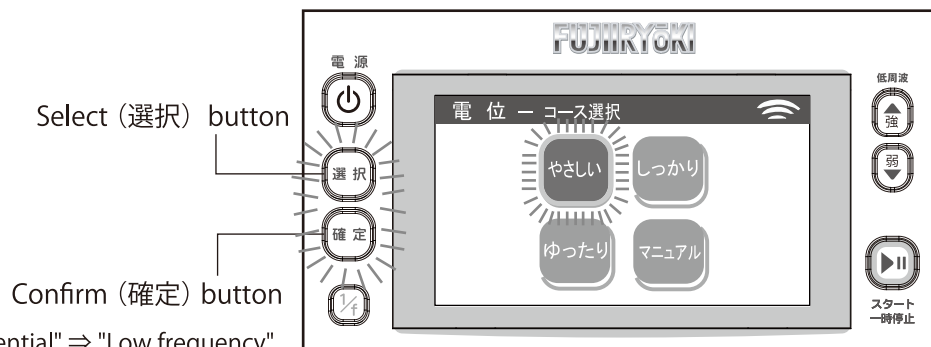

※Please change "Potential" ⇒ "Low frequency" after turning off the power.

4 Begin the treatment.

The treatment begins when you press the Start/Pause (スタート / 一時停止) button.

(1) Easy (やさしい) setting



〈Easy setting〉

Easy course starts with the setting below.

Output (出力)	4500Vp (Peak Value)
Waveform (波形)	Wave 1 (波形1)
Frequency (周波数)	60Hz
offset	45 : 55
Timer (タイマー)	20 Mins (20分)

(2) Fast (しっかり) setting



〈Fast setting〉

Fast course starts with the setting below.

Output (出力)	14000Vp (Peak Value)
Waveform (波形)	Random (ランダム)
Frequency (周波数)	Random (ランダム)
offset	Random (ランダム)
Timer (タイマー)	60 Mins (60分)

※For random, waveforms, frequencies, and offsets are automatically selected every three minutes.

(3) Comfortable (ゆったり) setting



〈Comfortable setting〉

Comfortable course starts with the setting below.

Output (出力)	1000Vp (Peak Value)
Waveform (波形)	Wave 1 (波形1)
Frequency (周波数)	60Hz
offset	50 : 50
Timer (タイマー)	8 hours (8時間)

(4) Manual (マニュアル) setting

The manual setting is a setting that allows you to choose your favorite settings.

※For details on how to set the manual course, refer to "Manual setting method" on pages 17 and 18.

After selecting, please start treatment with Start/Pause (スタート / 一時停止) button.

※When the output displayed is "Vp" it indicates the peak value.

〈Manual setting method〉

The screen ① is displayed if you select “Manual (マニュアル)” on the course selection screen

① Select the output.

If you press the Select (選択) button the potential icon selection changes from

4500Vp⇒9000Vp⇒14000Vp
⇒Random(ランダム)⇒4500Vp⇒…

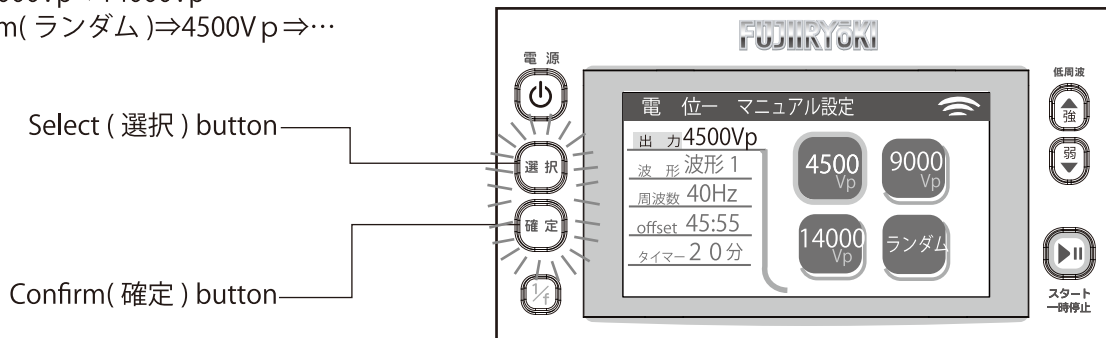

Press the Confirm(確定) button to move to the next screen.

② Select the waveform.

If you press the Select (選択) button the waveform icon selection changes from Wave 1 (波形 1)⇒

Wave 2 (波形 2)⇒Wave 3 (波形 3)⇒

Return back⇒Wave 1 (波形 1)⇒…

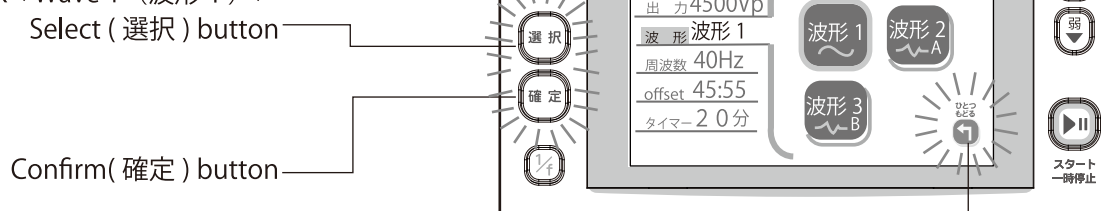

Press the Confirm(確定) button to move to the next screen.

If you use the Select (選択) button to select Return back (ひとつもどる) and then push the Confirm (確定) button you will return back to the output selection (出力選択) screen.

③ Select the frequency.

If you press the Select (選択) button the frequency (周波数) icon selection changes from

40Hz⇒60Hz⇒100Hz

⇒Return back (ひとつもどる)⇒40Hz⇒…

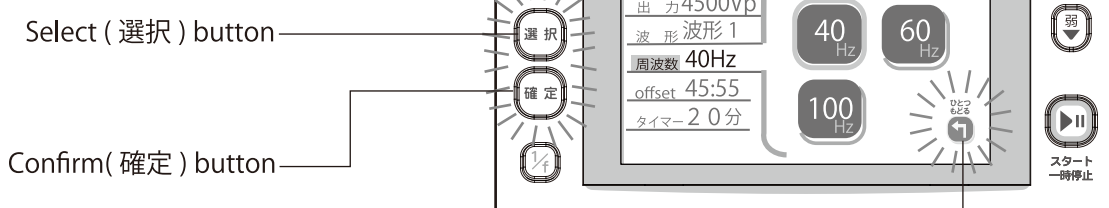

Press the Confirm(確定) button to move to the next screen.

If you use the Select (選択) button to select Return back (ひとつもどる) and then push the Confirm (確定) button, you will return back to the waveform selection (波形選択) screen.

④ Select the offset.

If you press the Select (選択) button the offset selection changes from 45:55⇒35:65⇒25:75
⇒Return Back (ひとつもどる)⇒45:55⇒...

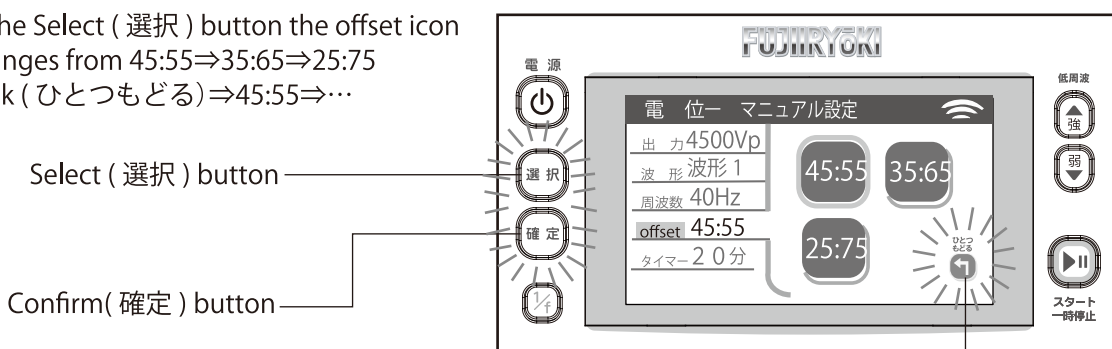

Offset ratios

They represent positive/negative ratio of the crest value of the output waveform.

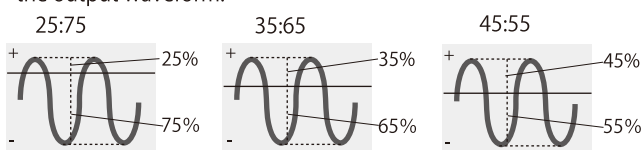

If you use the Select (選択) button to select Return Back (ひとつもどる) and then push the Confirm (確定) button you will return back to the Frequency Selection (周波数選) screen.

Press the Confirm(確定) button to move to the next screen.

⑤ Select the timer

If you press the Select (選択) button the timer (タイマー) icon selection changes from 20 Min (20分)⇒40 Min (40分)⇒60 Min (60分)
⇒Return back (ひとつもどる)⇒20 Min (20分)⇒...

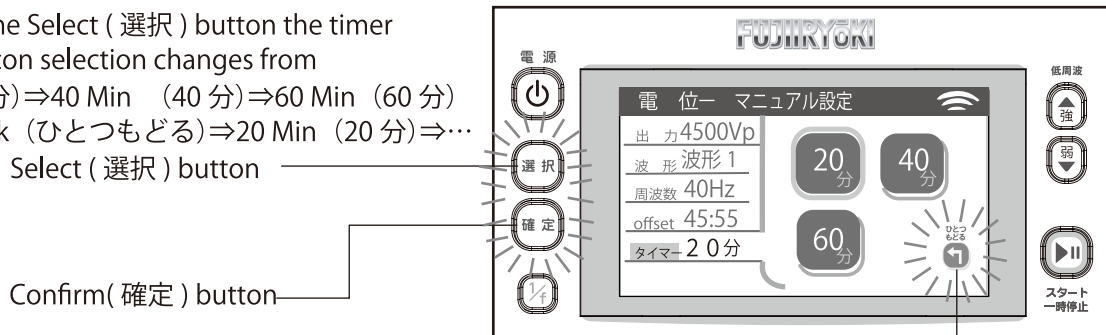

Press the Confirm(確定) button to move to the next screen.

If you use the Select (選択) button to select Return Back (ひとつもどる) and then push the Confirm (確定) button you will return back to the offset selection (offset 選択) screen.

⑥ Start the treatment

Press the Start/Pause (スタート / 一時停止) button to start the treatment.



Start/pause (スタート / 一時停止) button

5 During the treatment, the display like the one below is displayed on the display panel.

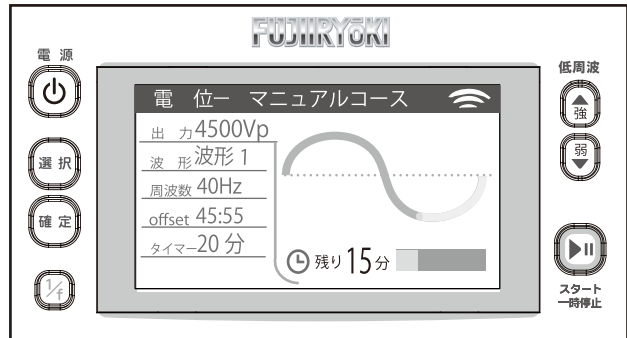

※Illustration is of manual setting (マニュアルコース).
 ※The movement of the waveform is an image.

〈Pause function〉

During treatment if you press the Start/Pause (スタート / 一時停止) button the treatment can be paused. Pause can be canceled by pressing the Start/Pause (スタート / 一時停止) button again and the treatment can be resumed.

(The timer is stopped while paused.)

※It automatically turns off when the pause state continues for 10 minutes.



※Illustration is of manual setting (マニュアルコース).

Start/Pause (スタート / 一時停止) button

6 The treatment ends.

When the set timer time has elapsed, a beep sound is heard and a message appears on the display panel as shown on the right, and the power turns off after 2 seconds.

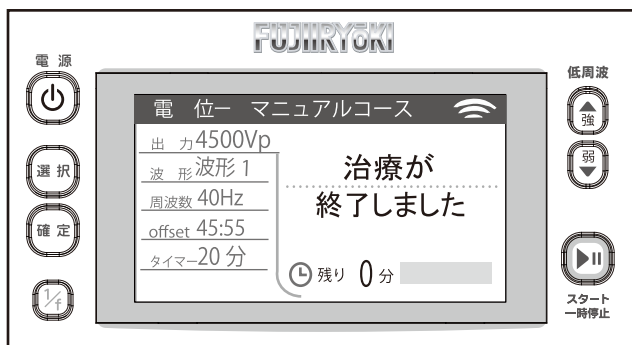

※Illustration is of manual setting (マニュアルコース).



How to use the detector (Usage method etc.)

How to insert the dry cell

When the battery of the electricity detector runs out, please replace the dry cell according to the following procedure.

1 Open the lid.

Push the indented part of the lid and slide it to open the lid.

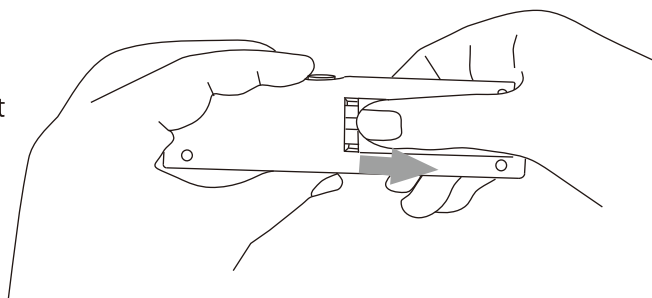

2 Insert the dry cell.

Insert the AA batteries correctly from the minus end according to the display. It will not work if there is a mistake in the way batteries are inserted.

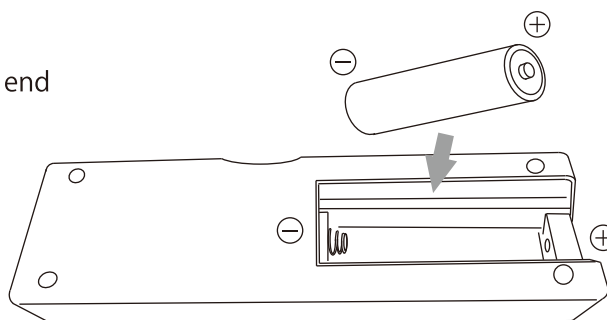

3 Close the lid.

Insert the protrusion of the lid in the recess of the electric detector case and close the lid. Please push the lid till you hear a "click" sound.

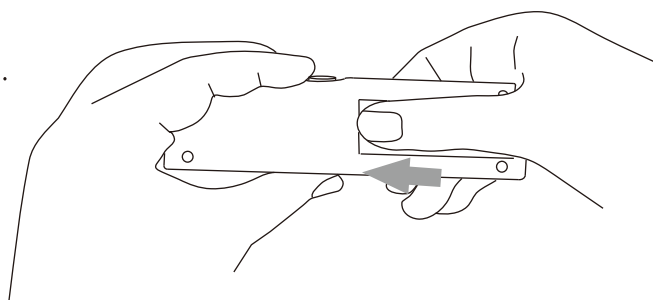

Usage method

Push the button of the voltage detector and apply it to the conduction sheet. When the occurrence of electric potential is detected, it will inform you with a "beeping" sound.

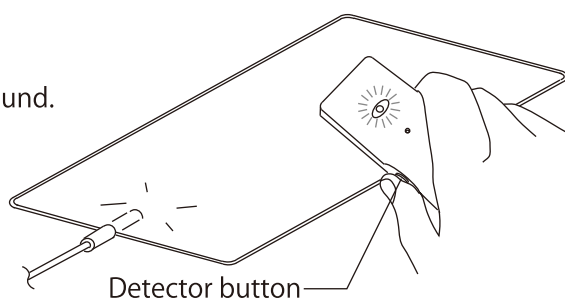

※There is no reaction even if you put the detector on your body during treatment.

How to use low frequency treatment device (Usage method etc.)

Preparations before use

1 Place the unit in a horizontal position so that it does not collapse.

2 Attach the low frequency pad to the low frequency pin.

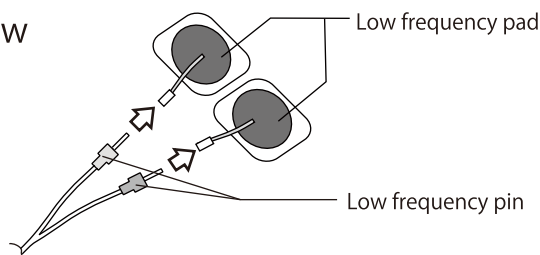

3 Connect the low frequency cord.

Insert the low frequency plug into the low frequency cord socket of the main unit.

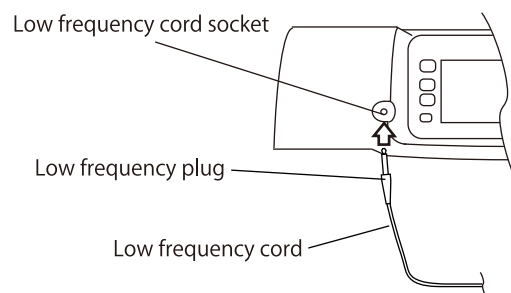

4 Connect the power cord.

Insert the power connector into the power cord socket on the main unit.
Plug the power plug into a household outlet.

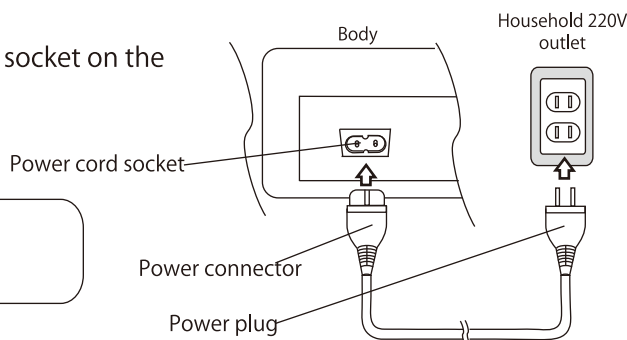

Please confirm that it is securely inserted to the base.

5 Paste the low frequency pad on your body.

Please refer to page 22 for an example of pasting method.

⚠ Warning About low frequency pad

- Please note its weakness with respect to sticky substances such as poultice and weeds.
- Please do not use it on a part with scratches.
- When the skin is rough, when there are burns or inflammation etc. please stop using it immediately.
- When using a low frequency pad, if rash, redness, itching, etc. appear, stop using it immediately and consult your dealer or a customer service office.
- When using a low frequency pad, please paste it carefully so as not to overlap or touch a metal object (necklace, belt clock etc). Also, please paste low frequency pads in a way that they do not overlap each other.
- When attaching the low frequency pad, be sure to make close contact with the skin. In some cases, it may cause skin disorders
- If cosmetic items remain on the skin, such as lotion and oil, and in case of perspiration or dirty skin, the adhesion of the low frequency pad will decrease and it will be difficult to attach. Please wash the skin thoroughly with soap and paste it when completely dry.
- Before peeling off the low frequency pad from the skin, please make sure to turn off the power button on the main unit.
- Do not use expired items or low frequency pads that have lower adhesive strength. Even if it is fixed with a tape band or inner cloth, not only the appropriate effect cannot be obtained but there is also a danger that a strong stimulus may suddenly be applied or in some cases, skin injuries such as burns may occur.
- In order to ensure the safety of the product, quality management is carried out at the manufacturing vendor. Please use genuine low frequency pads. Please note that we cannot assume responsibility for defects caused by the use of other similar products.

Examples of pasting positions of low frequency pad

! Please paste the pad correctly.

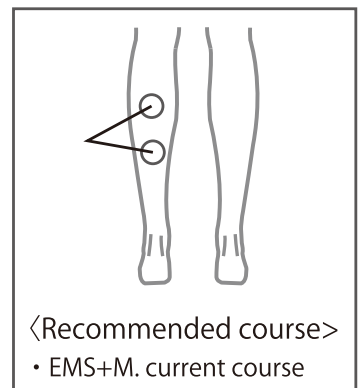
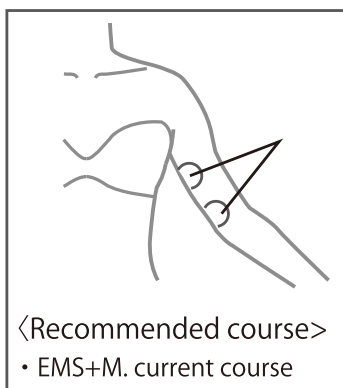
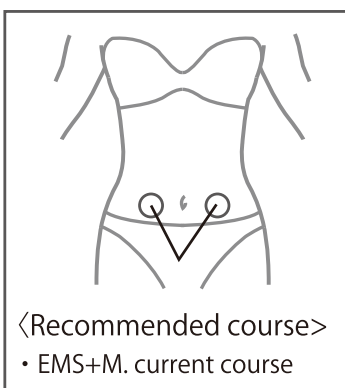
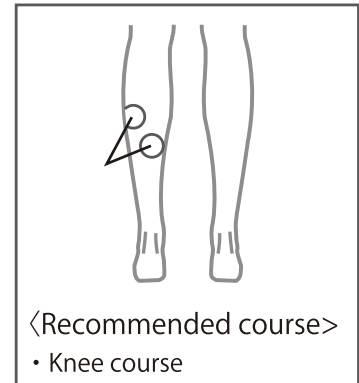
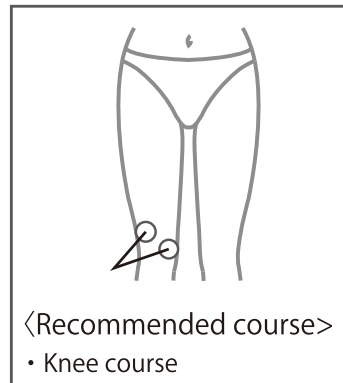
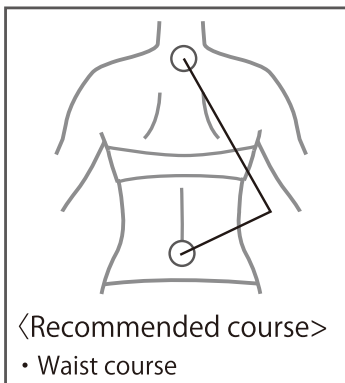
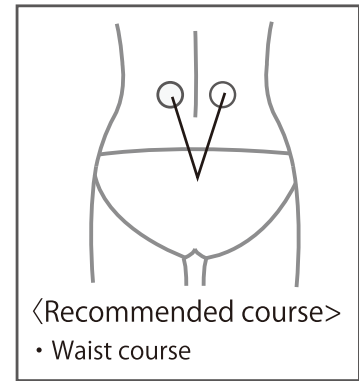
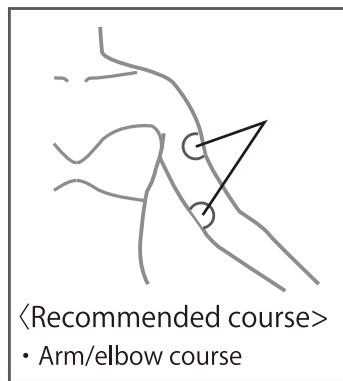
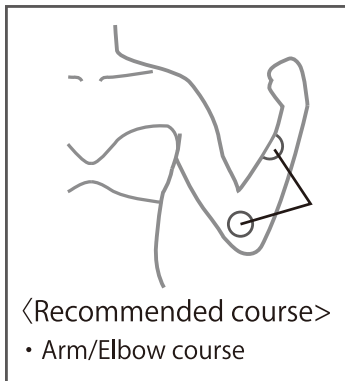
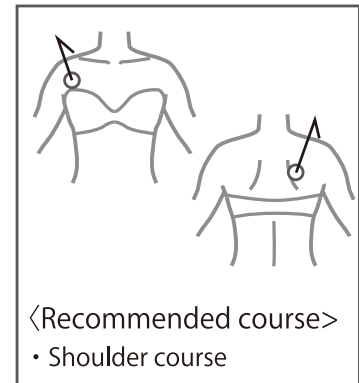
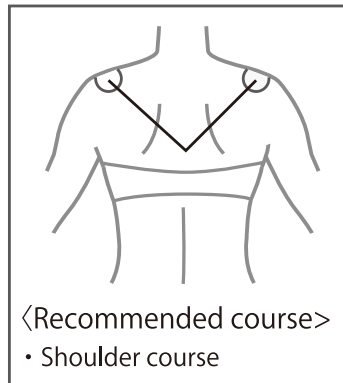
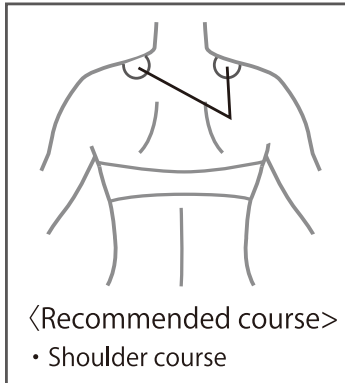

Low frequency pad replacement timing

The low frequency pad is a perishable item.

Any of the following indicates that it is time for replacement, and in this case, stop using the pad and promptly change to a new one

- It has been used for more than 20 times (attachment/detachment of low frequency pad)
- It has been opened for more than a month
- Adhesion of the pad has decreased, deterioration symptoms such as drying/abnormality of surface can be seen
- It has not been opened but has reached the expiration date (mentioned on the back of the package)

Operation method

1 Turn on the power.

Press the power (電源) button on the main unit and turn on the power.

When you press the power button, the display as shown below appears on the display panel, and after 2 seconds it switches to 2. Treatment selection screen.

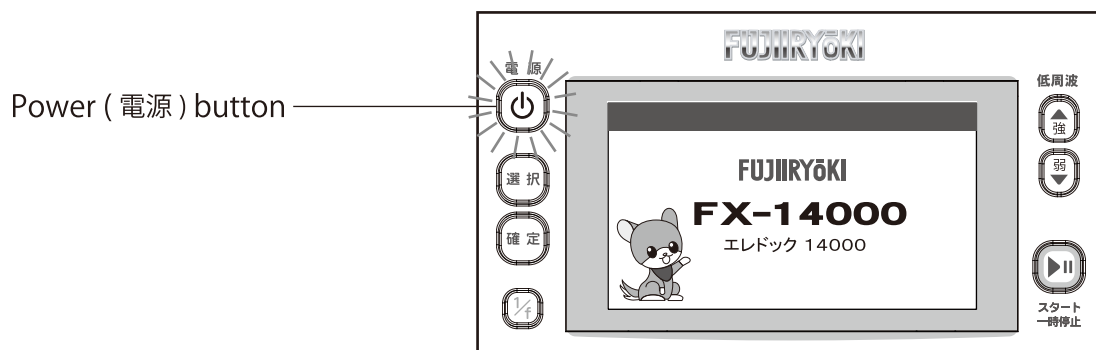

2 Select low frequency.

Use the select (選択) button to select the low frequency (低周波) and then press confirm (確定) button.

If you press the select (選択) button the treatment icon changes from "Potential" (電位) ⇒ "Low frequency" (低周波) ⇒ "Potential" (電位)

When you press the Confirm (確定) button for "Low frequency" (低周波), the screen will change to 3 Low frequency setting selection screen.

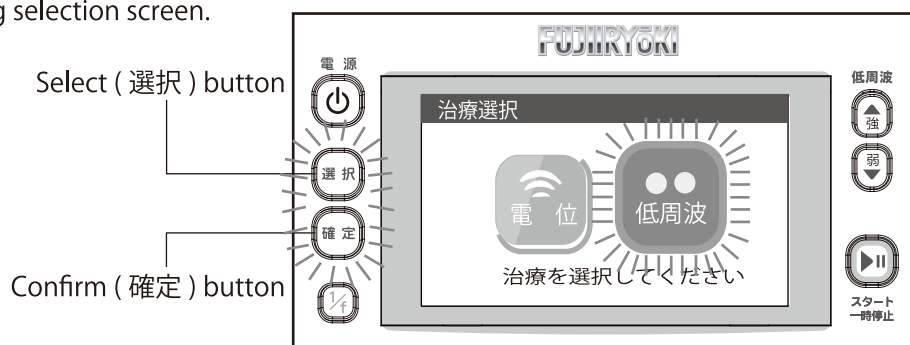

3 Select your favorite course.

Select the course with Select (選択) button

If you press the select (選択) button the low frequency icon changes from

Shoulder (肩) ⇒ Arm/Elbow (腕/ひじ) ⇒ Waist (腰) ⇒ Knee (ひざ) ⇒

EMS+M. Current (EMS+M. カレント) ⇒ Shoulder (肩) …

Select the course and decide with the confirm (確定) button.

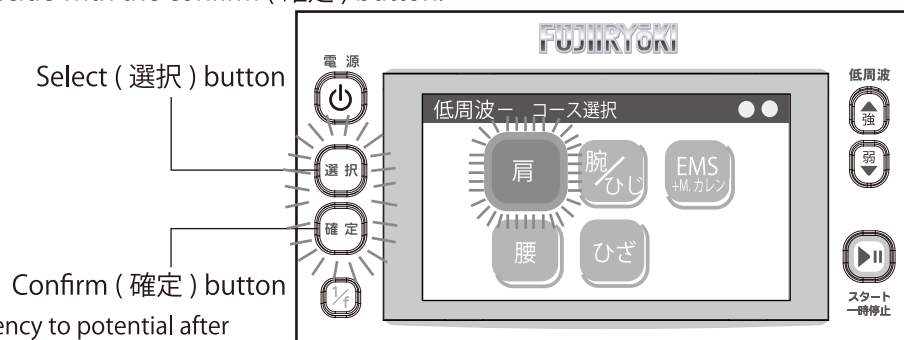

※Change from Low frequency to potential after switching off the power.

4 Begin the treatment.

Press the Start/Pause (スタート / 一時停止) button to begin the treatment.

Even when the Start/Pause (スタート / 一時停止) button is pressed the output level is "0", in this case there is no output.



※Illustration is of the shoulder course.

5 Set the output LV (level).

The Output can be started by raising the low frequency level with the low frequency output Strong (低周波出力強) button. During the treatment if you press the Low frequency output Strong (低周波出力強) button and Low frequency output Weak (低周波出力弱) button the low frequency output (出力) LV can be adjusted. Low frequency output (出力) LV can be set in 14 increments of 0.5 from "0" → "0.5" → "1" → ... → "6.5" → "7"

Low frequency output Strong (低周波出力強) button

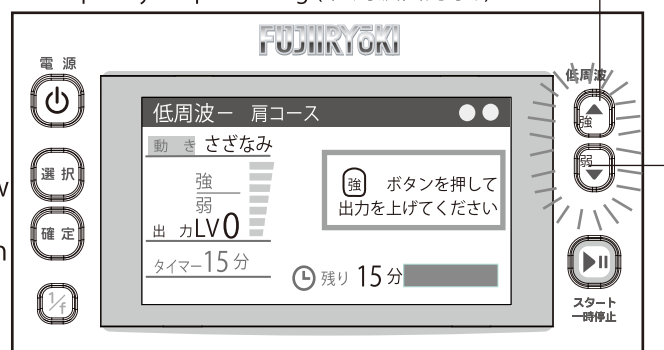

※Illustration is of the shoulder course.

Low frequency output Weak (低周波出力弱) button

6 During the treatment, the display as shown below is displayed on the display panel.

※The output (出力) LV bar display is rounded off.
(Eg.) In case of LV4, 4 bars light up.
In case LV4.5, 5 bars light up.



At the time of setting up the EMS+M. current (EMS+M. カレント) course if M. current (M. カレント) is displayed there is no body sensation due to weak output.

〈Pause function〉

You can pause by pressing the Start/Pause (スタート / 一時停止) button during treatment. Pause can be canceled by pressing the Start/Pause (スタート / 一時停止) button again to resume the treatment. (The timer is stopped while paused.)

When treatment is interrupted, the output (出力) LV (level) automatically becomes "0". If you want to resume treatment please repeat the procedure from 5.

※It automatically turns off when the pause state continues for 10 minutes.

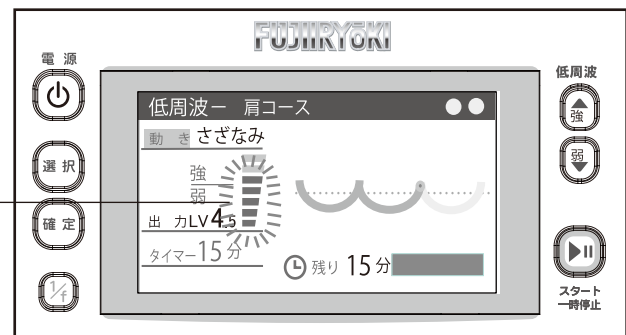

※Illustration is of the shoulder course.

※The movement of the waveform is an image. The low frequency output may not match the movement of the waveform.

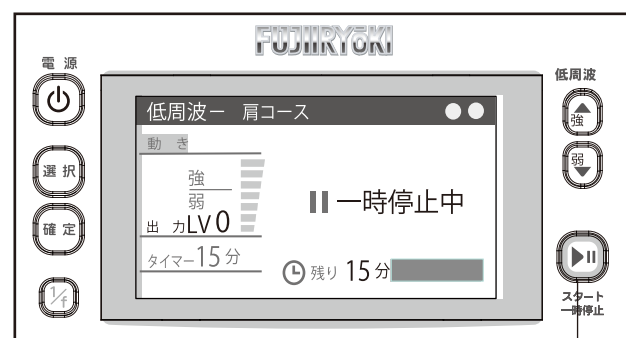

※Illustration is of the shoulder course.

Start/Pause (スタート / 一時停止) button

7 The treatment ends.

When the set timer (タイマー) time has elapsed, a beep sound is heard and a message appears on the display panel as shown on the right, and the power turns off after 2 seconds.



About low frequency pad storage

- When storing the low frequency pad please paste it on the transparent film surface which has "ON" written on it. It is hard to peel off if stuck to the side with "NO", shortening the life of the low frequency pad.
- After using the low frequency pad, return it to the original transparent film, put it in a bag and please keep at room temperature.
- Expiration date is indicated in the low frequency pad bag. Do not use expired low frequency pad.
- The low frequency pad is a perishable item. Please change it when adhesion decreases.

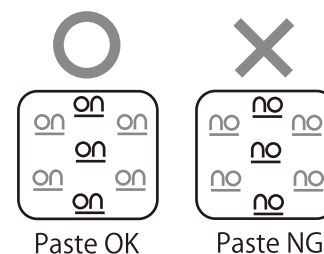

Feature Description

(1) 1 / f fluctuation

You can add fluctuations to the potential output and low frequency output by pressing the 1 / f button during potential treatment and low frequency treatment.

1 / f fluctuation is a setting that gives a non-regular rhythm like a murmur of a breeze or a stream.

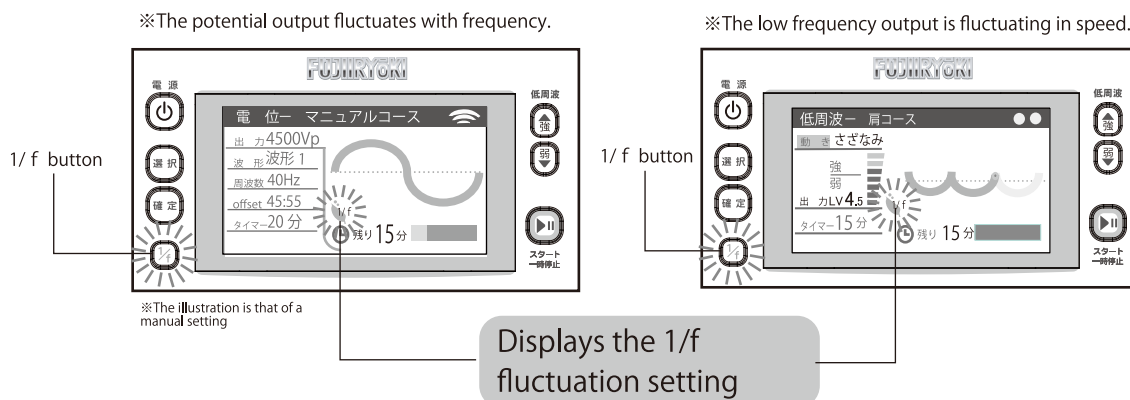

(2) Memory resume

Will start with the mode and the setting that was used for last treatment.

(3) Quiet mode

Switch between "mute" (消音します) ⇔ "cancel mute" (消音解除します) by simultaneously pressing the Low frequency output Strong (低周波出力強) button and Low frequency output Weak (低周波出力弱) button when selecting the treatment mode or setting.

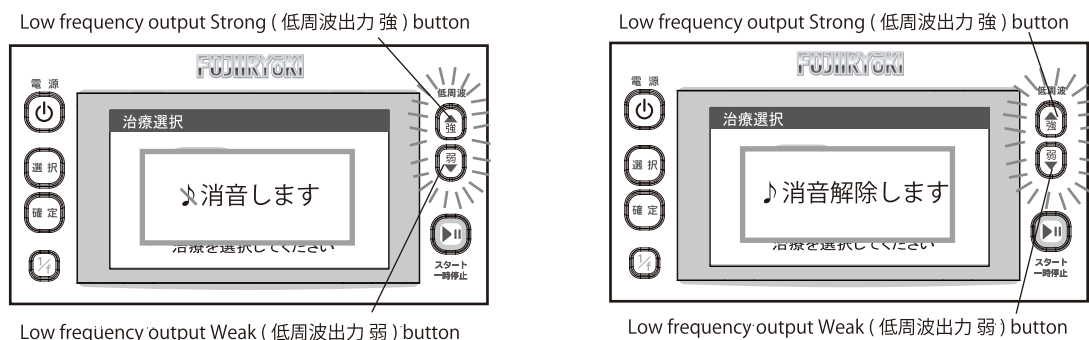

(4) Night mode

Pressing the select (選択) button and confirm (確定) button during treatment will make the display screen darker. Press the select (選択) button and confirm (確定) button again to cancel.

(5) Change background

You can switch the background by pressing "1/f button" on the setting screen. There are three background patterns, and it is set to "forest" at the time of purchase.



Forest



Denjiro

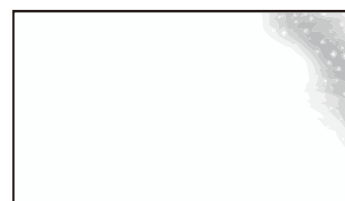

Starry sky

Is there a breakdown?

Eliminate the following situations but do not try to fix. Please contact your place of purchase for repair.

Situation	Probable reason	Treatment
Cannot turn on	Is the power cord disconnected from the power outlet?	Please insert the power cord's power plug firmly into the power outlet.
	Is the power cord's power connector disconnected from the power cord socket?	Please insert the power cord's power connector firmly into the power cord socket of the main unit.
【When using electric potential therapy device】		
Potential therapy can not be selected	Is the low frequency cord connected to the low frequency cord socket of the main unit?	If you are inserting the low frequency cord into the low frequency cord socket of the main unit while performing electric potential therapy it cannot be selected. When performing electric potential treatment, please do not insert anything in the low frequency cord socket of the main unit.
No potential output	Is the conduction sheet plug of the conduction sheet inserted deep into the main conduction sheet plug socket?	Please insert the conduction sheet plug firmly into the power supply sheet plug inlet of the main unit.
Error display (Error 888) (エラー 888)	Is the conduction sheet plug of the conduction sheet firmly inserted all the way in?	Please insert the conduction sheet plug of the conduction sheet tightly and fully.
	Is the conduction sheet deteriorated?	Conduction sheets deteriorate as they are used. Using a deteriorated conduction sheet may result in electric shock. Please replace every two years.
【When using the voltage detector】		
No sound and no lamp lights up	Are the batteries exhausted?	If the battery is exhausted, replace it with a new dry battery.
	Is the potential treatment in progress?	Please start the electric potential therapy.
【When using the low frequency treatment device】		
There is no stimulation. Stimulus is weak.	Is the low frequency cord missing?	Insert the low frequency cord firmly to the base of the cord socket of the main unit.
	Are low frequency pads touching or overlapping each other?	Turn off the power of the main body once, please change the position so that low frequency pads do not overlap.
	Is the low frequency output level set to "0"?	Press low frequency output strong button and increase low frequency output level.
	Has one of the low frequency pads moved from your body?	Turn off the power of the main unit once and attach the low frequency pad again.

Situation	Probable reason	Treatment
【When using the low frequency treatment device】		
Stimulation is interrupted.	Is there a crack or damage in the low frequency cord?	Please stop using it and replace it with a new one.
Low frequency pad does not stick.	Is the film attached to the low frequency pad still attached?	Please use it after peeling off the film attached to the low frequency pad.
	Is the surface of the low frequency pad dirty?	Please remove the dirt from the surface of the low frequency pad. If it does not recover even when removed replace with a new one.
Skin turns red. Skin is scratchy.	Have you been treating for a long time?	Treatment at the same location should be 15 minutes or less. Also, please keep an interval between successive treatments to the same location. It may cause injury or poor physical condition.
	Is the low frequency pad damaged?	The low frequency pad is a perishable item. Please replace the damaged one with a new one.
	Are you treating at a strong output level?	Please treat at a level which is in accordance to your physical condition.
Error is displayed Error-111 (エラー 111)	Has the low frequency pad moved from your body?	When the low frequency pad is peeling off, please stick it in a way that the two low frequency pads do not overlap.

Main Specifications and Principles (Shape / structure and principle)

〈Main specifications and item specifications〉

Item		Specification			
Generic name		Low frequency/potential combination household therapy device (JMDN Code: 70995000)			
Brand name		ELEDOG			
Product Code		FX-14000			
Medical equipment certification number		227AKBZX00119000			
Measurement		Body Width 390 × Depth 340 × Height 145 mm Conduction Sheet Length 280 × width 1000 mm (Cord Length: Approximately 1.5 m)			
Power Cord Length		Approximately 2m			
Low frequency cord length		Approximately 1.75m			
Weight		Body 7.8 Kg Conduction sheet about 1.2Kg			
IP Protection Level (Water)		IPX1 (Only conduction sheet)			
Rated voltage/Rated frequency		AC220V 50/60Hz			
Potential treatment section	Rate power consumption (maximum)	20W			
	Electric treatment selection setting	Easy (やさしい)	Fast (しっかり)	Comfortable (ゆったり)	Manual (マニュアル)
	Output voltage (出力電圧) (Crest value)	4500Vp(Fixed)	14000Vp(Fixed)	1000Vp (Fixed)	4500Vp, 9000Vp, 14000Vp, Random (ランダム) (Select)
	Output waveform (出力波形)	Waveform (波形) 1(Fixed)	Waveform (波形) 1, Waveform (波形) 2, Waveform (波形) 3 (Random) (ランダム)	Waveform (波形) 1 (Fixed)	Waveform (波形) 1, Waveform (波形) 2, Waveform (波形) 3 (Select) (選択)
	Offset ratio (オフセット比率)	45 : 55 (Fixed)	45:55, 35:65, 25:75 (Random)	50:50 (Fixed)	45:55, 35:65, 25:75 (Select)
	Output frequency (出力周波数)	60Hz (Fixed)	40Hz, 60Hz, 100Hz (Random)	60Hz (Fixed)	40Hz, 60Hz, 100Hz (Select)
	Timer period (タイマー時間)	20 min (分) (Fixed)	60 min (分) (Fixed)	8 hours (時間) (Fixed)	20 min (分), 40 min (分), 60 min (分) (Select)
Low frequency treatment section	Rated power consumption (maximum)	10W			
	Low frequency treatment course selection	Shoulder (肩) course, Waist (腰) course, Knee (ひざ) course, Arm/Elbow (腕 / ひじ) course, EMS+M. current (EMS+M. カレント) course			
	Output voltage	70V			
	Oscillation frequency	Lower than 1.2KHz			
	Timer period	15 Min			
Safety setup		<p>①Even when the output circuit of the main unit is short-circuited, the current is limited by connecting a high-voltage current limiting resistor to the output of the high-voltage transformer to prevent shock to the human body.</p> <p>②An output limiting resistor is provided inside the low frequency wave form generating circuit so that the output current does not rise.</p> <p>③If the above-mentioned safety device cannot be controlled due to malfunction etc., stop the current supply no later than after 15 minutes for low-frequency therapy and 60 minutes for potential therapy (8 hours at output 1000 Vp) by using timer.</p>			
Components		①Body, ②Conduction sheet, ③Low frequency pad, ④Power cord, ⑤Insulation mat, ⑥Detector, ⑦Low frequency cord, ⑧Batteries (Manganese AA), ⑨Instruction manual, ⑩Packing box, ⑪Pouch			
Country of origin		Made in Japan			

〈Packaging〉

This product is composed of the following, some of the components are sold separately as supplements. Component: 1 per box

MEMO

